



OCEAN DISCOVERY



6+

C2302

ASV BEN
UNH CCOM/JHC

105 pcs



Center for Coastal
and Ocean Mapping
Joint Hydrographic Center

1

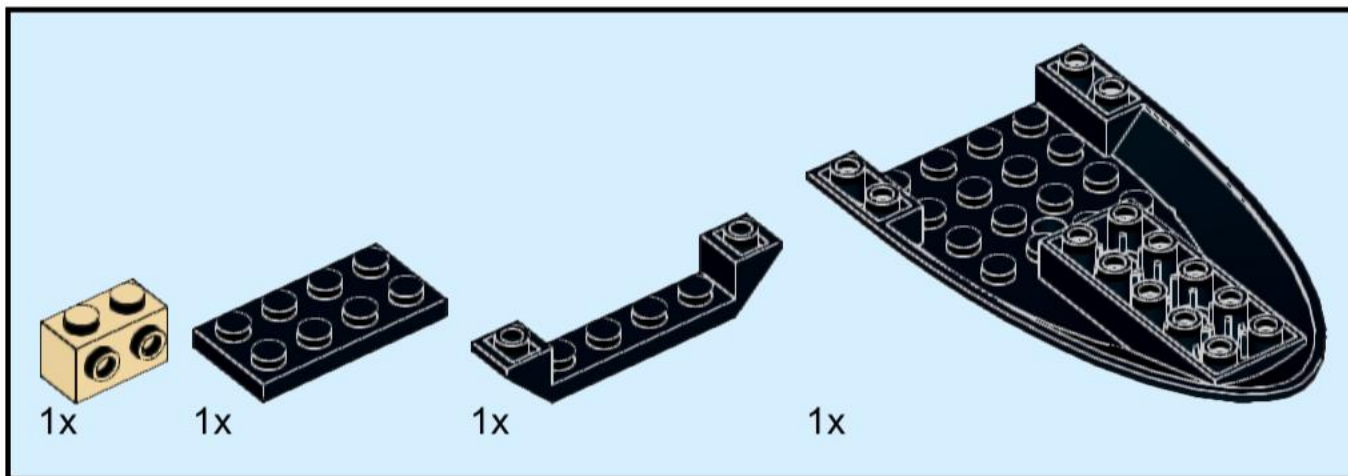
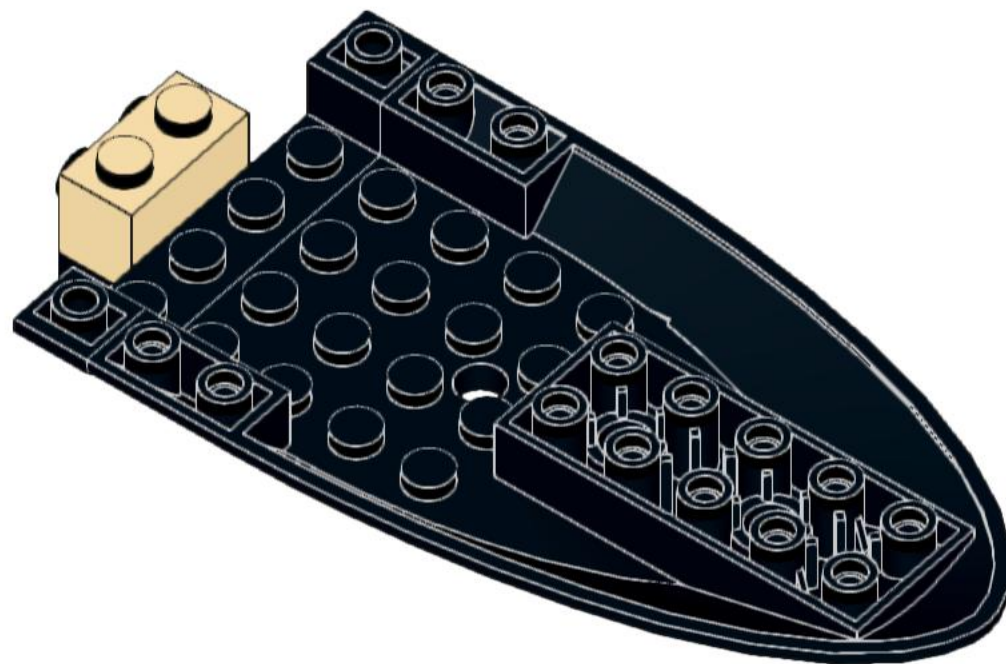

2

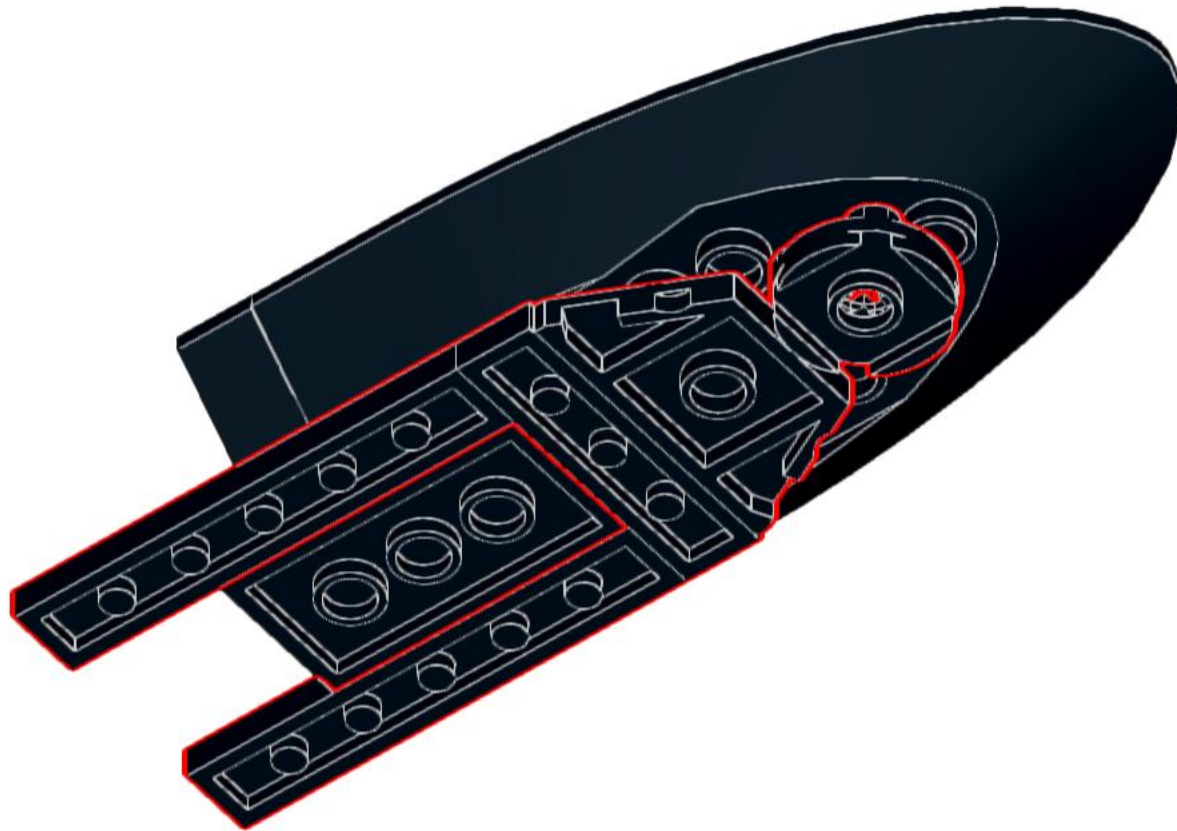
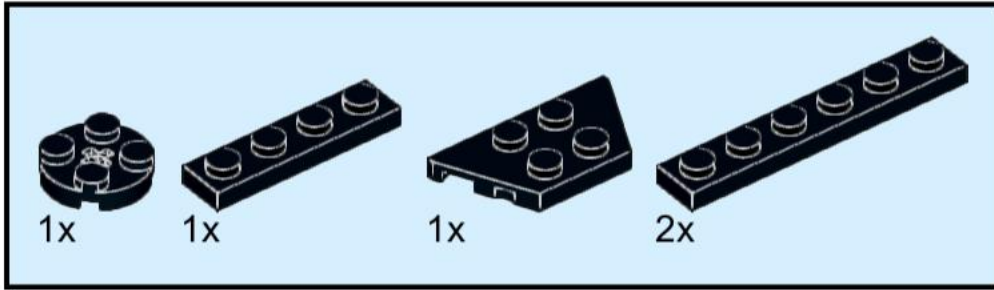

3

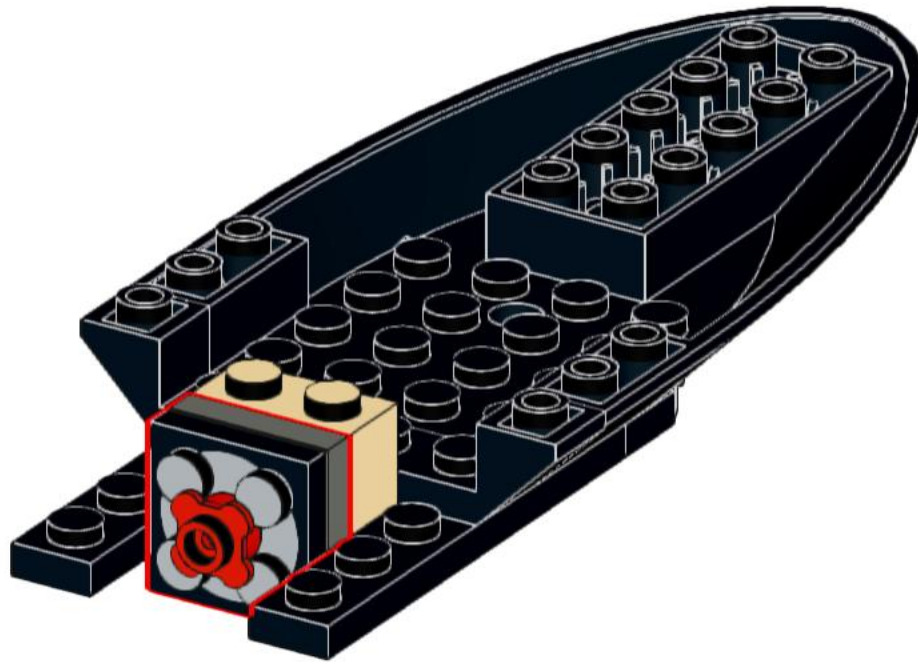
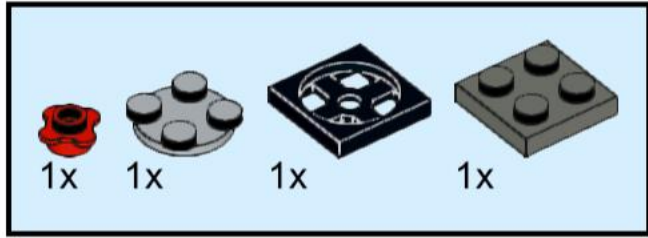

4

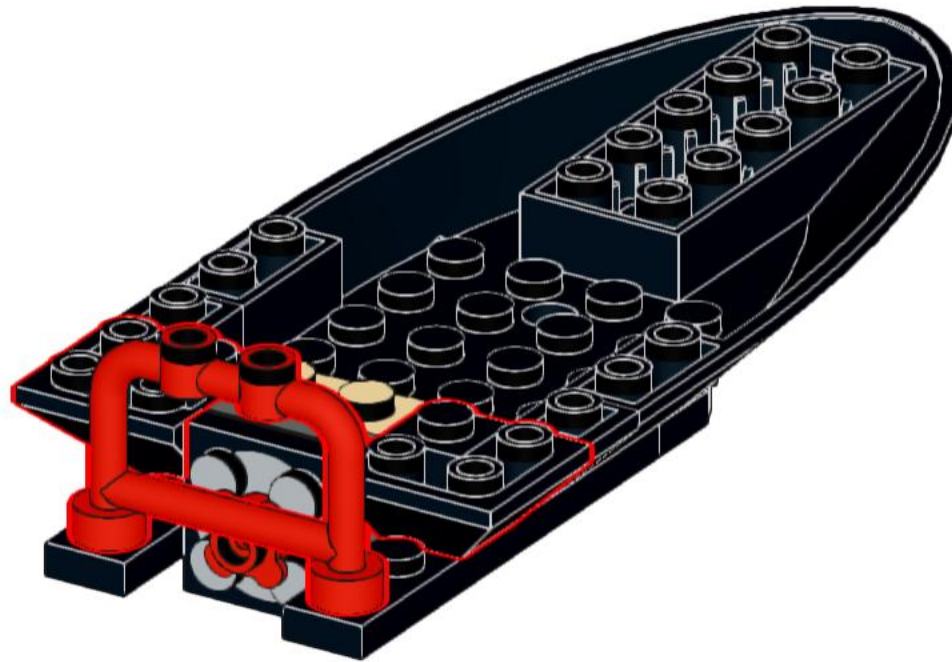
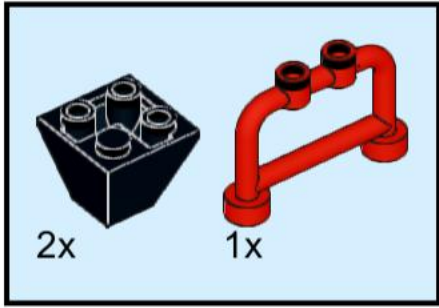

5

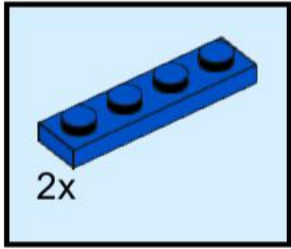

6

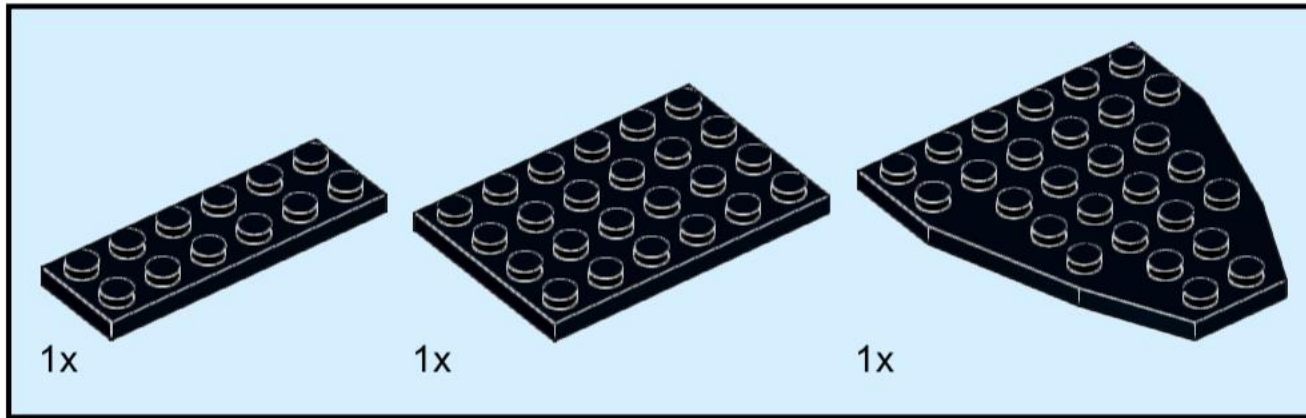

7

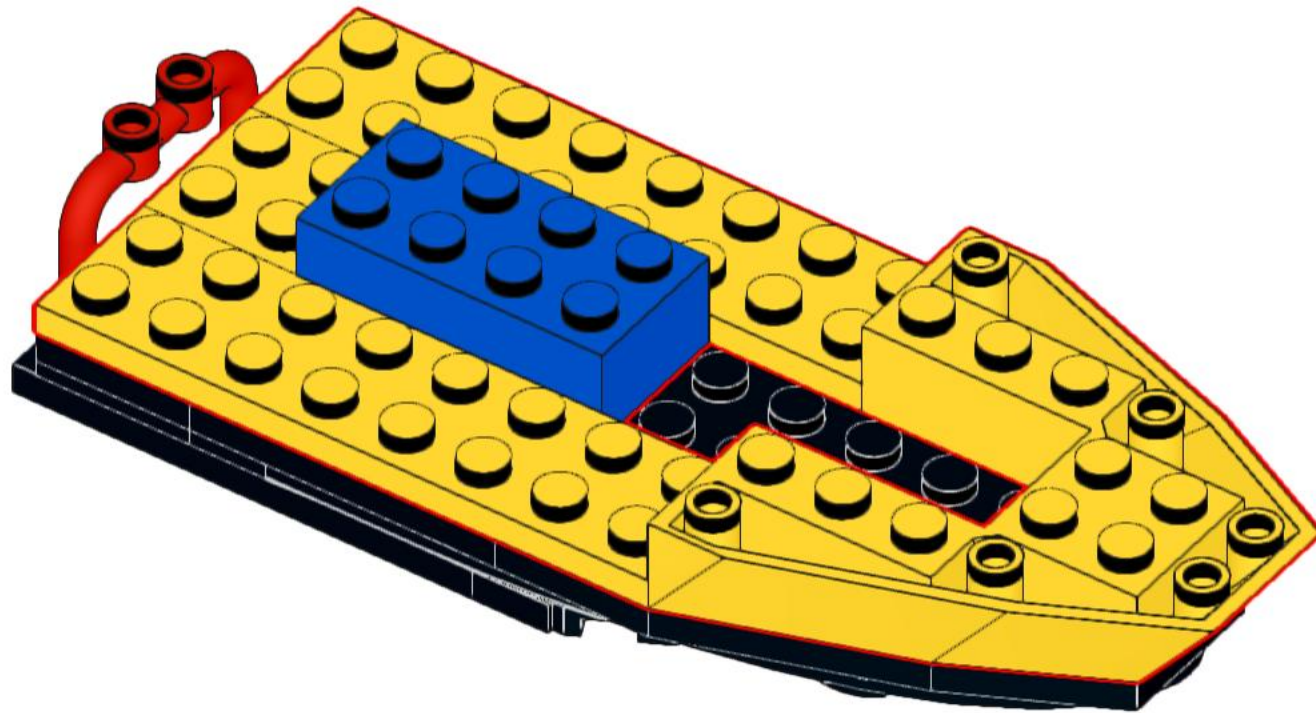
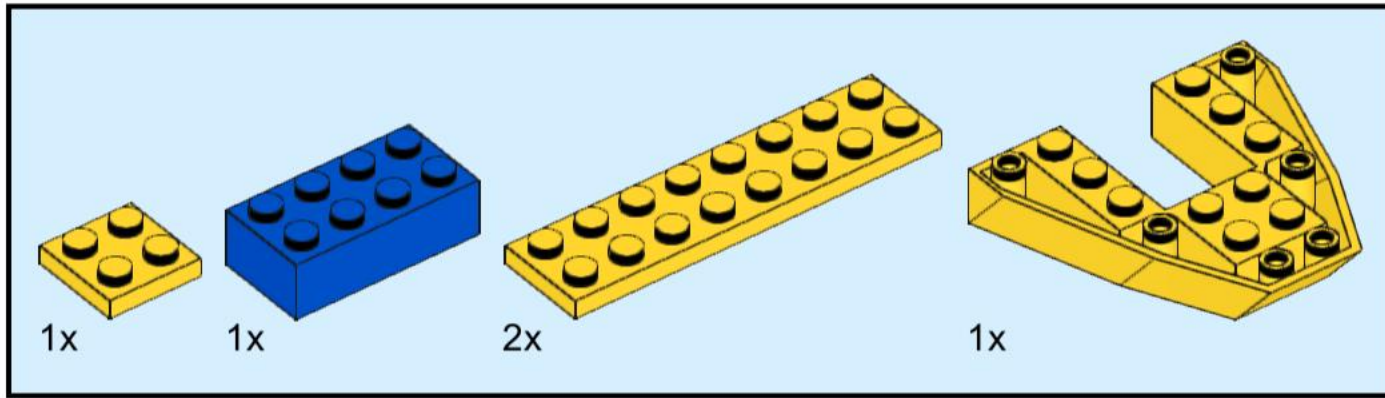

8

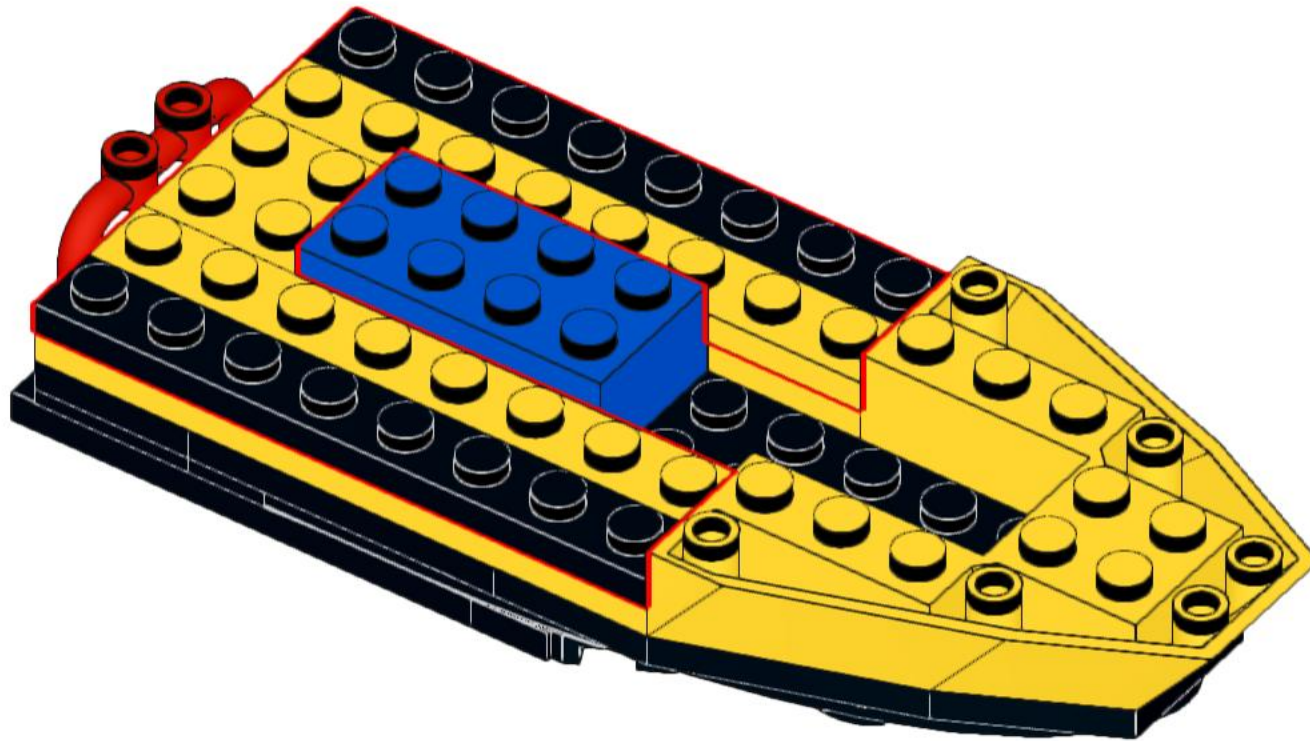
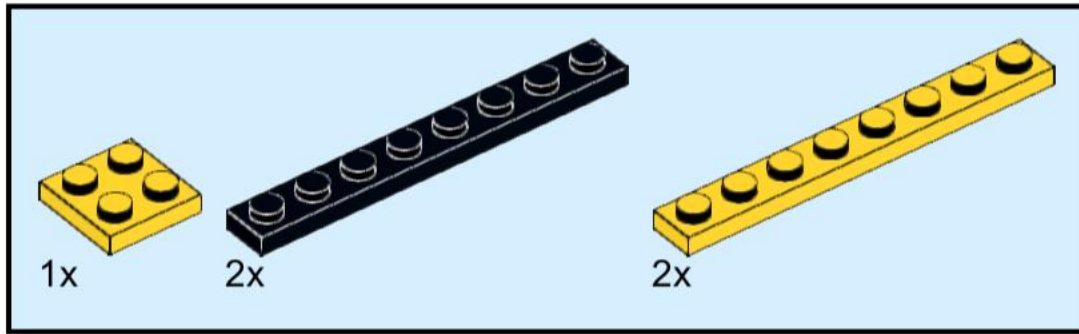

9

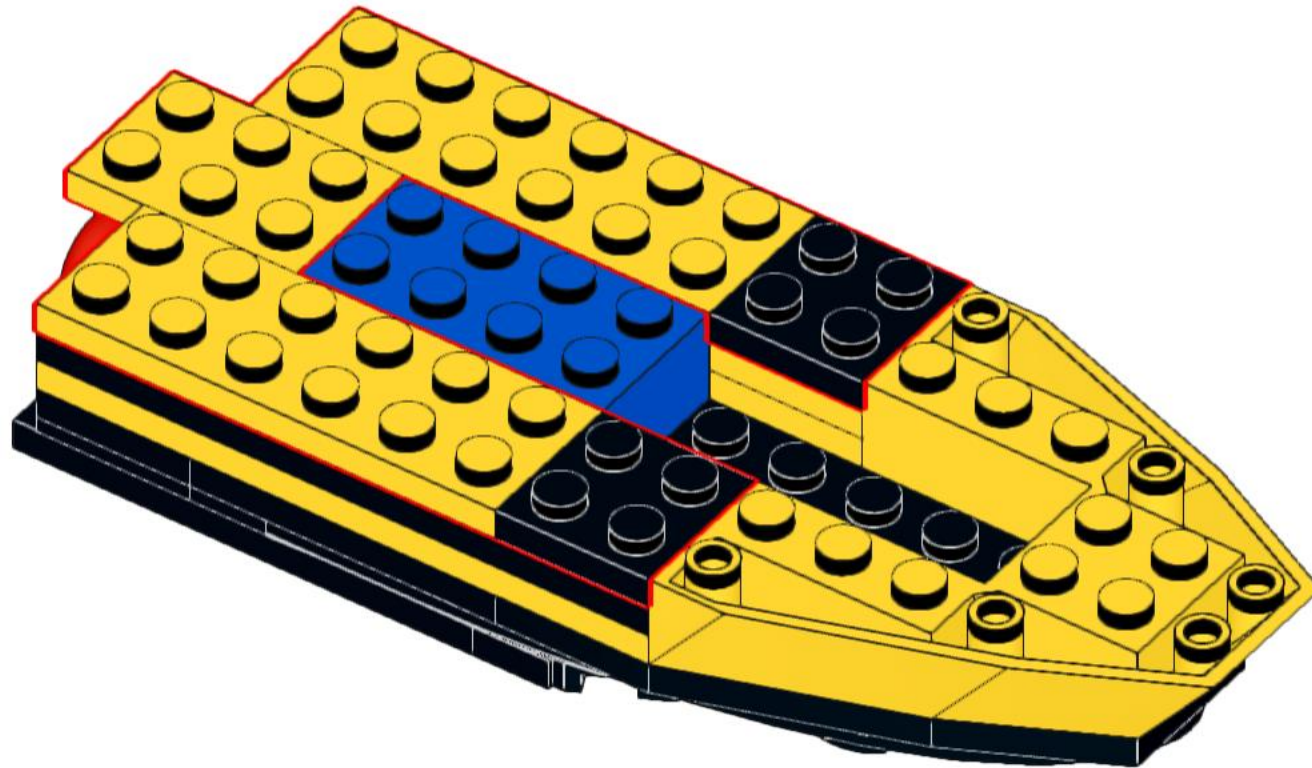
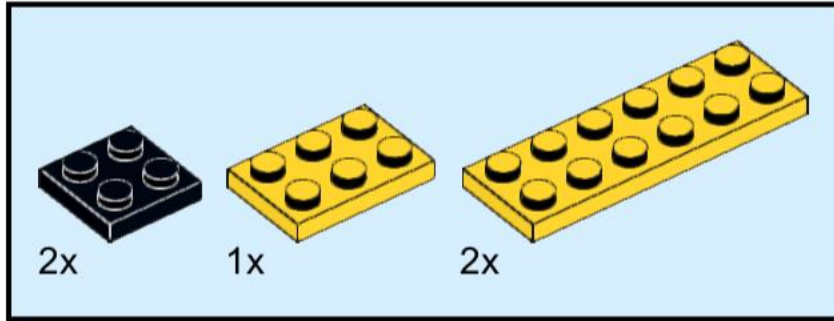

10

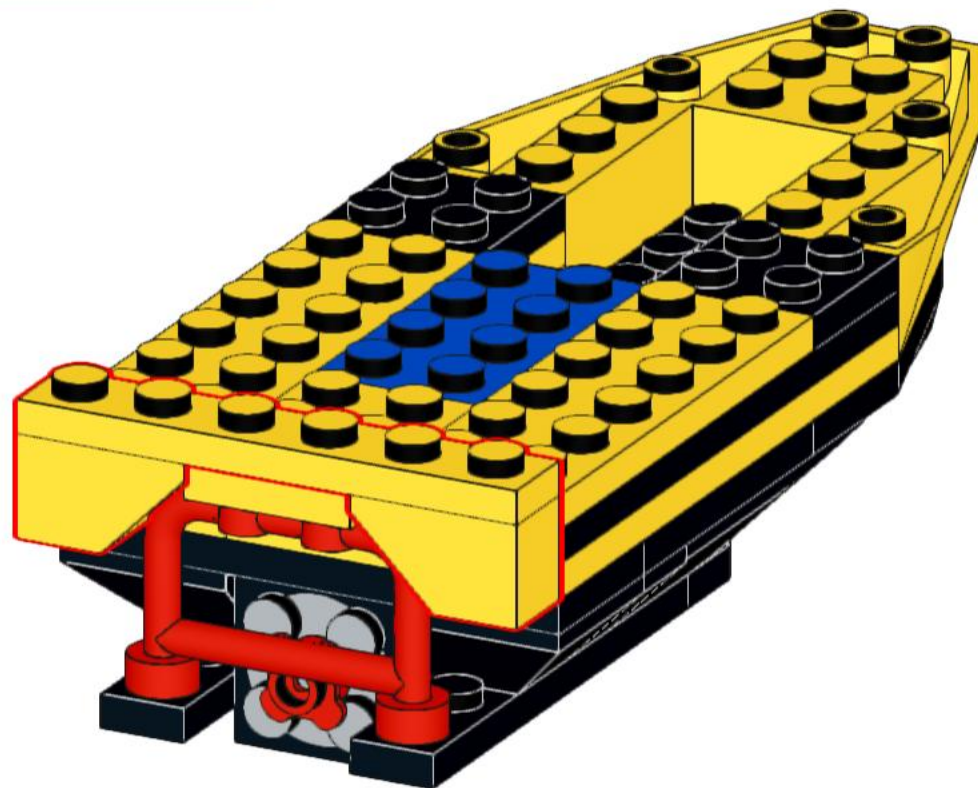
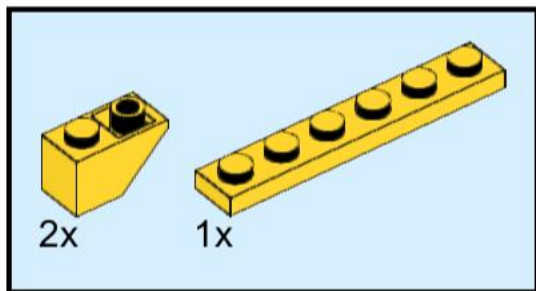

11

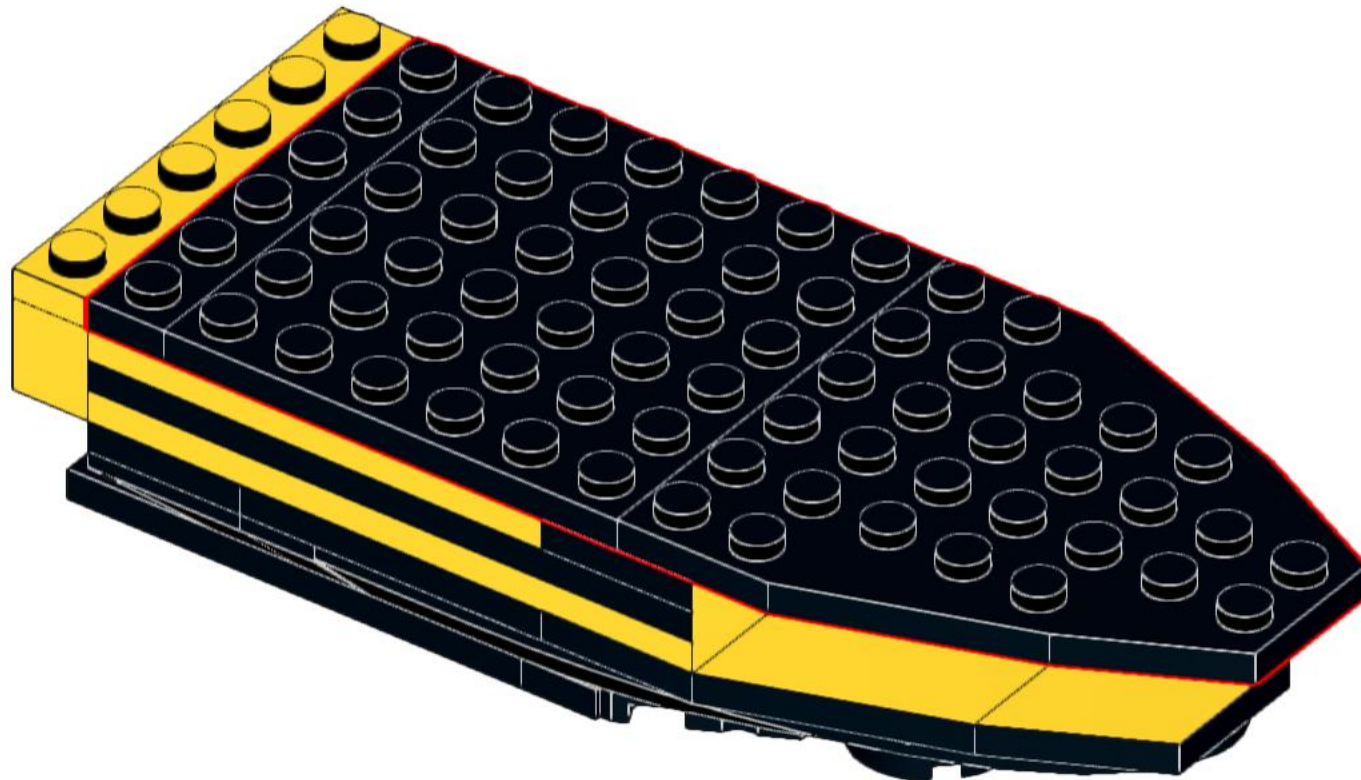
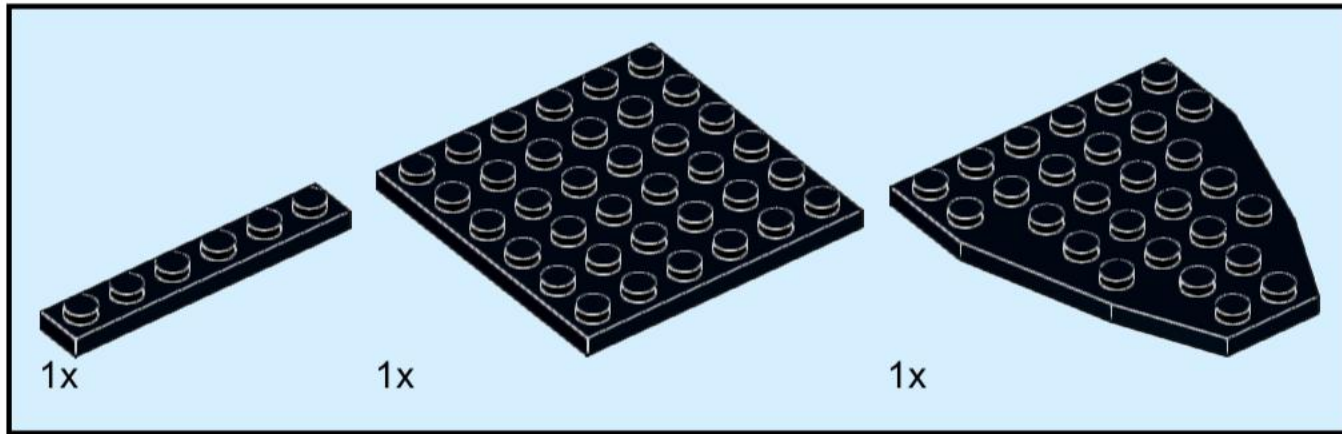

12

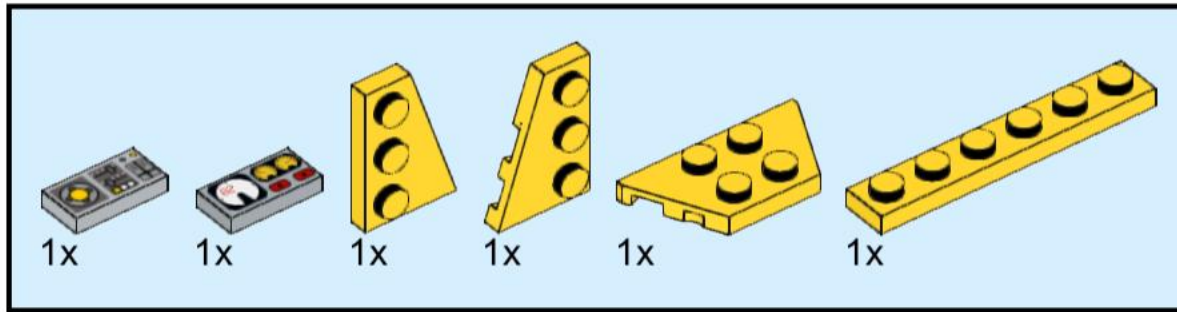

13

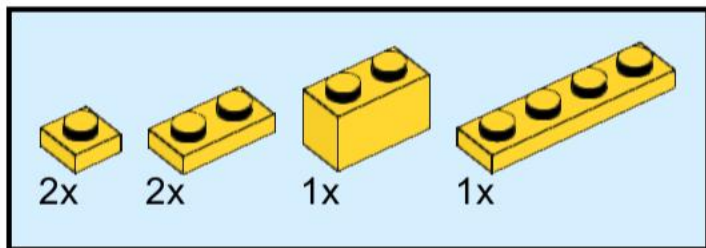

14

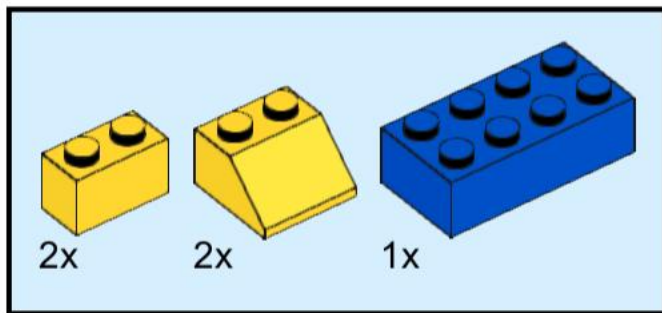

15

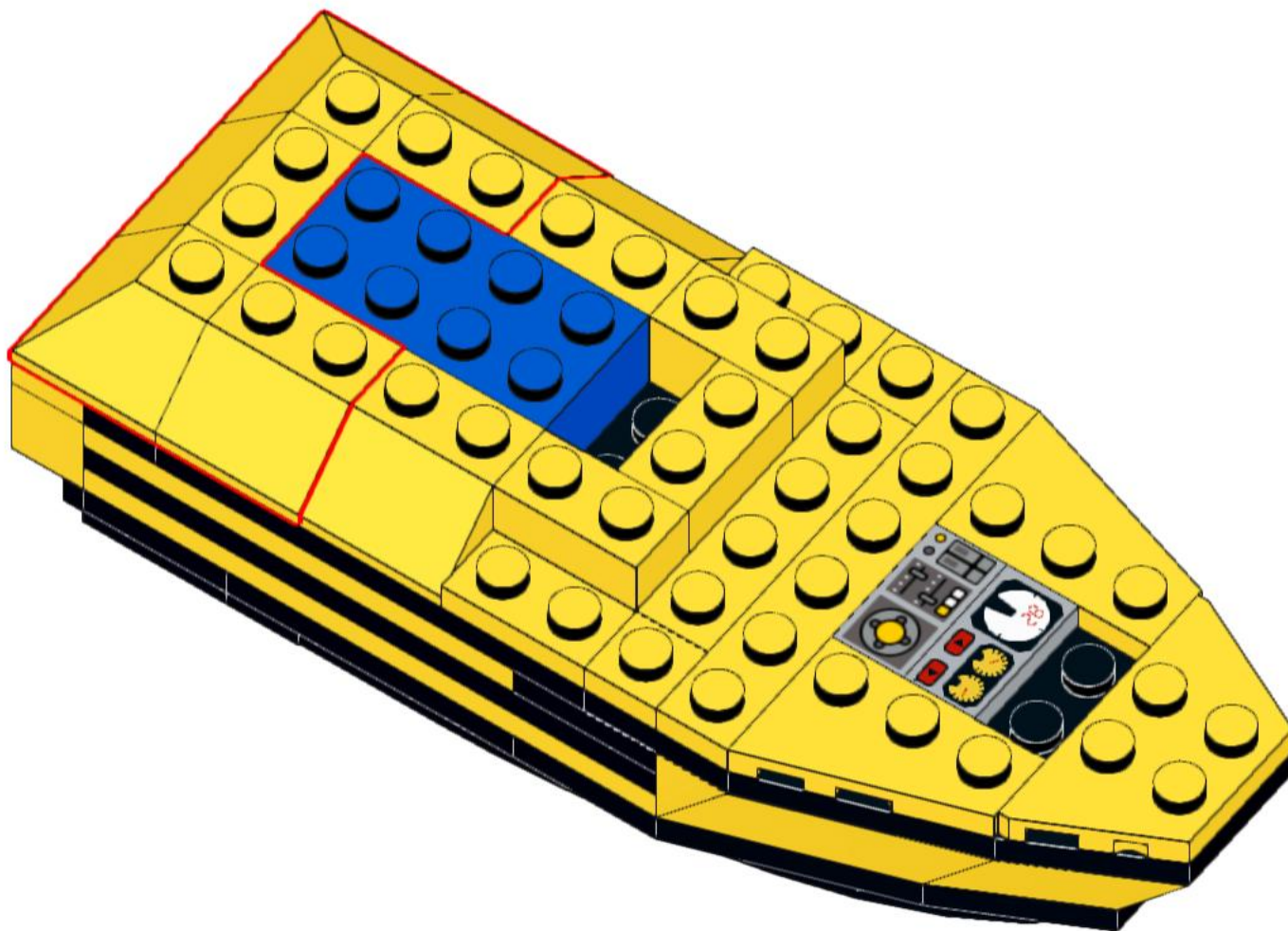
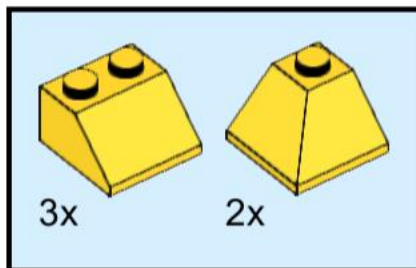

16

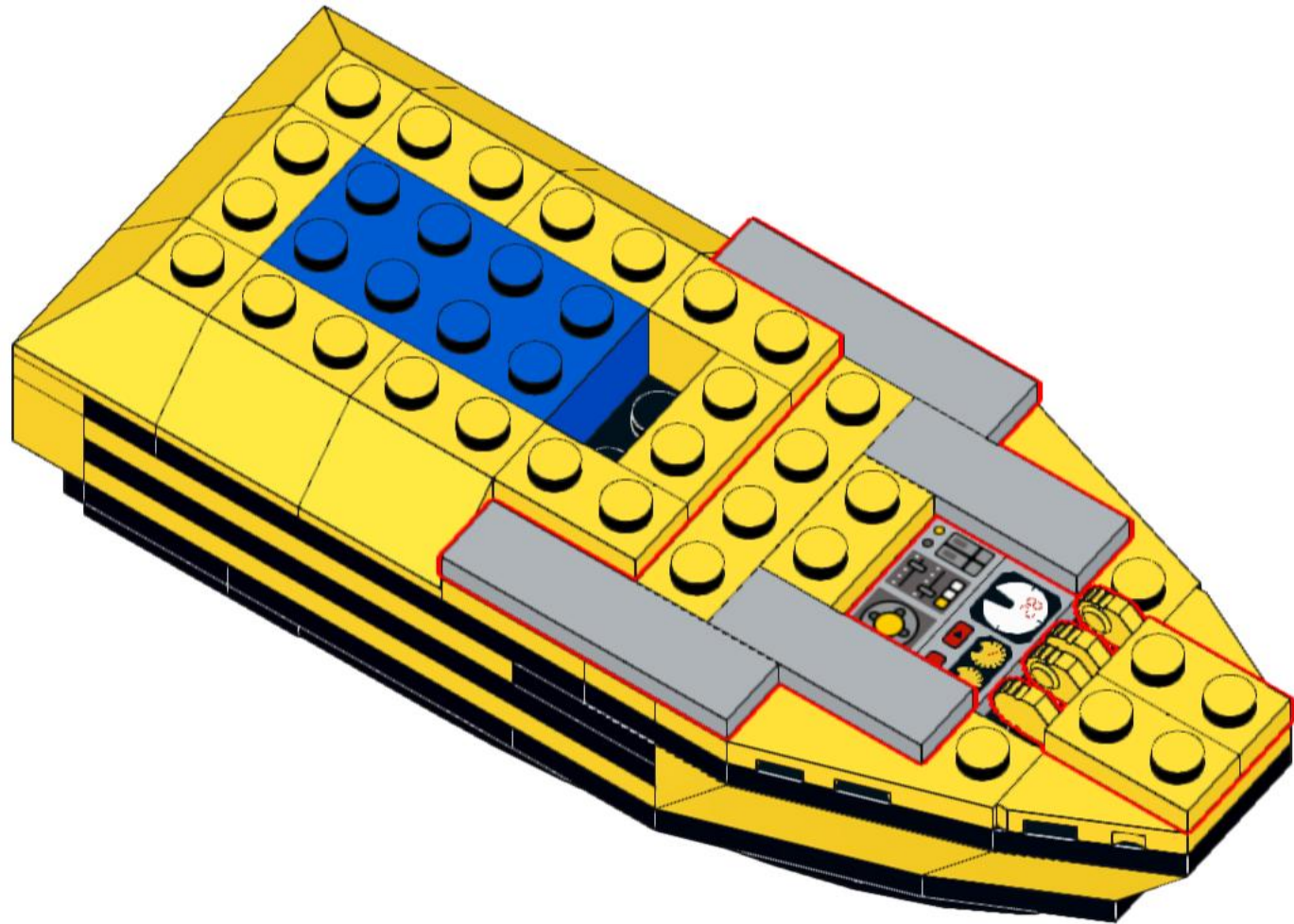
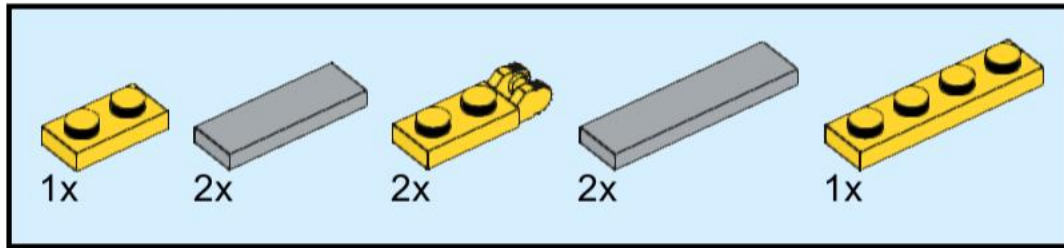

17

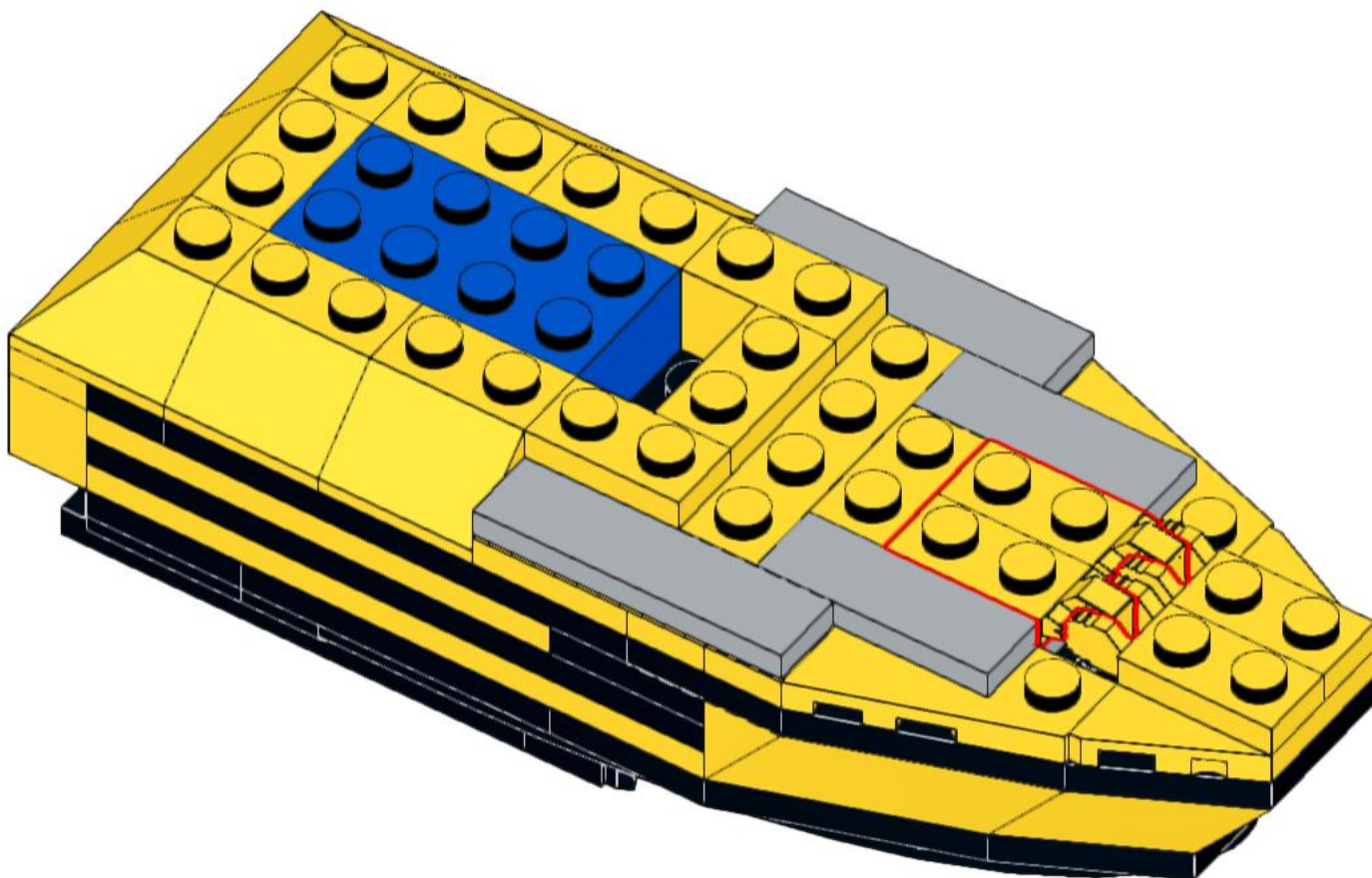
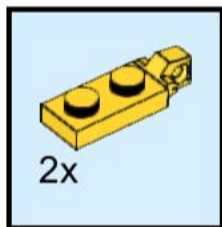

18

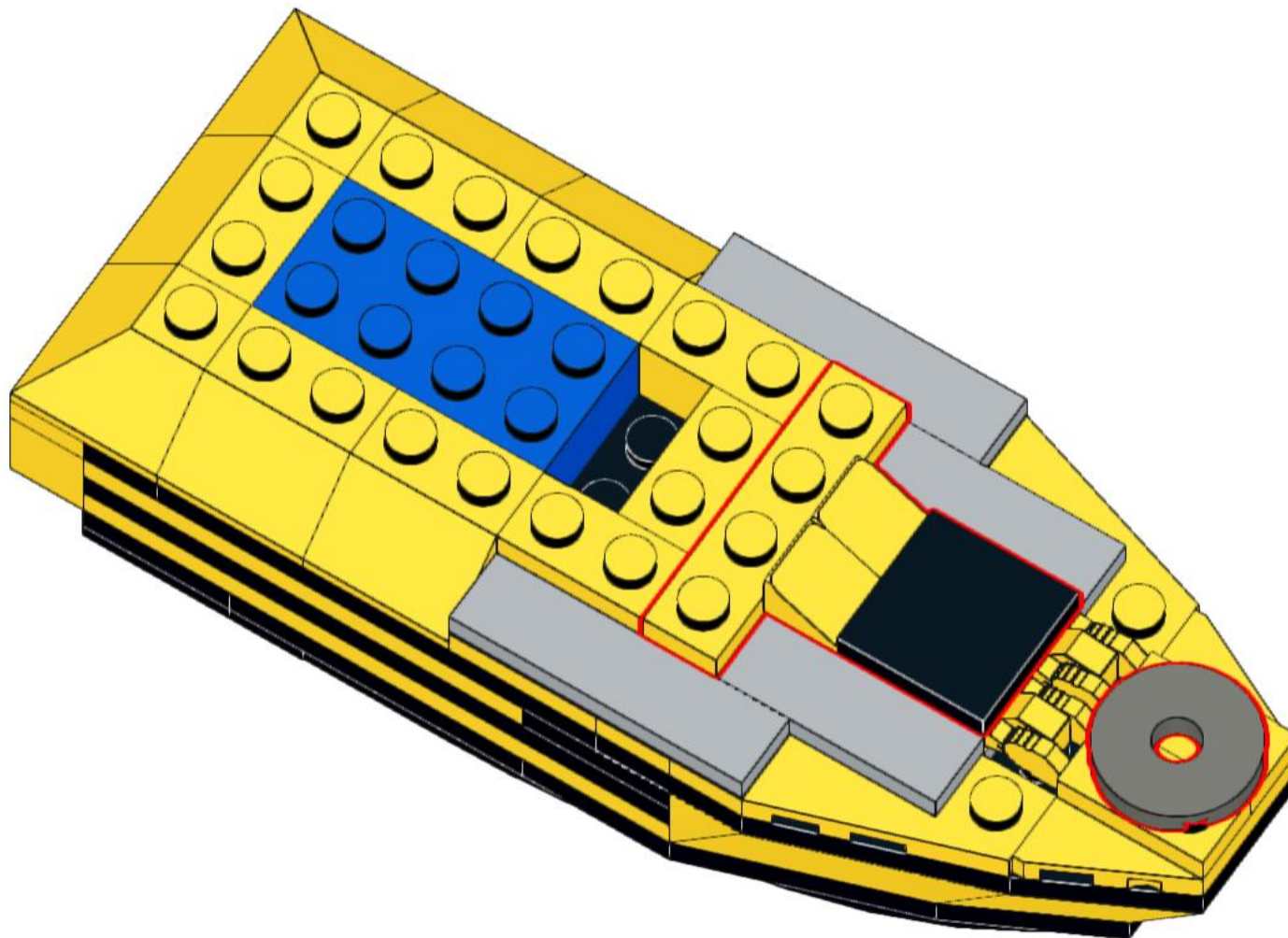
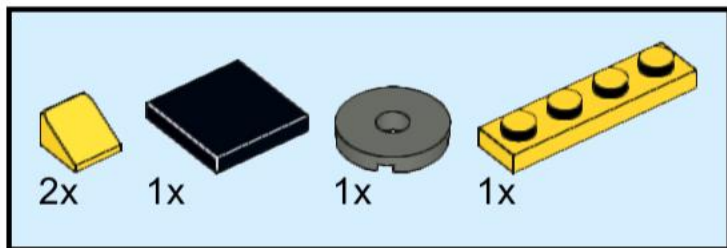

19

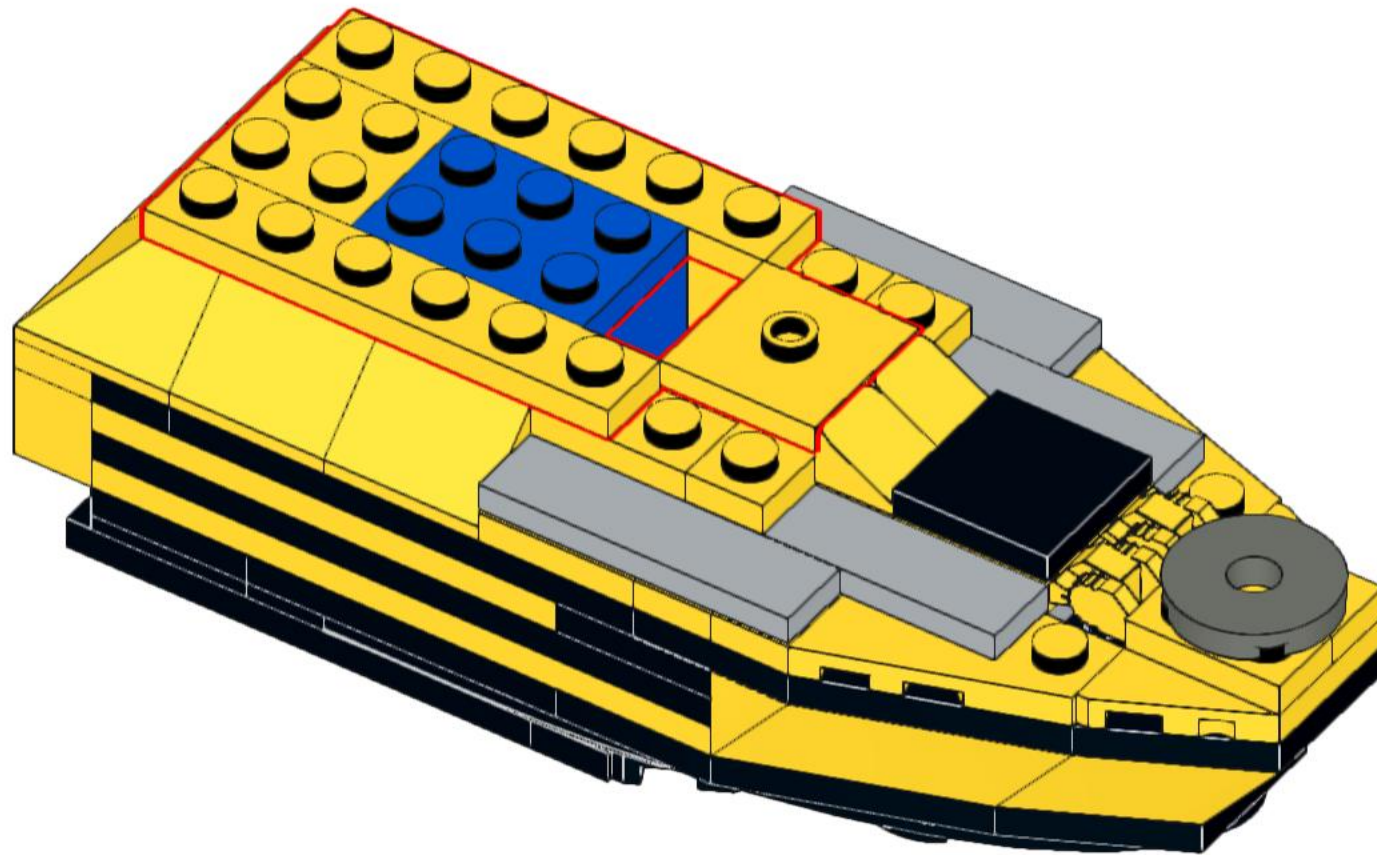
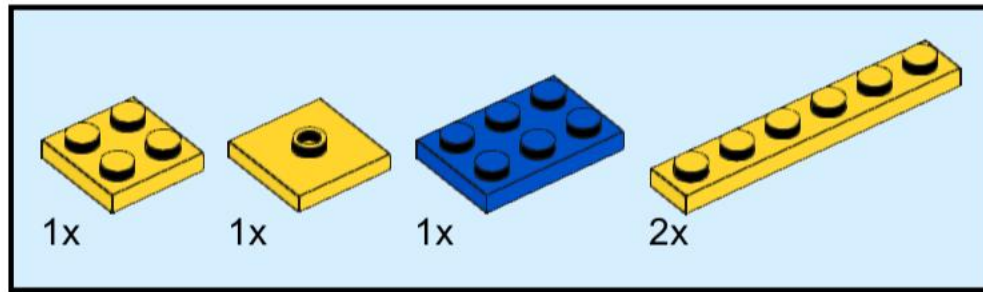

20

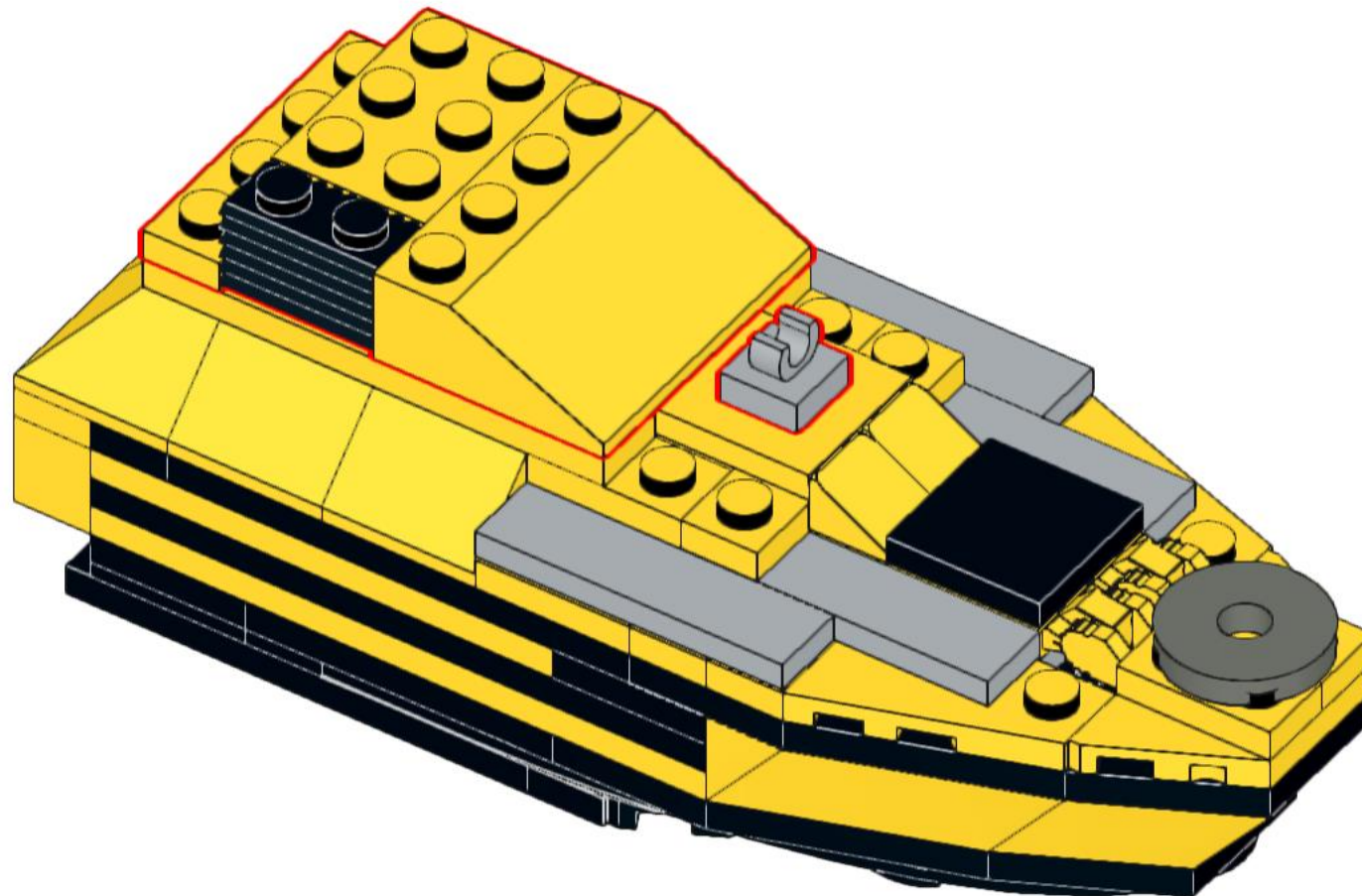
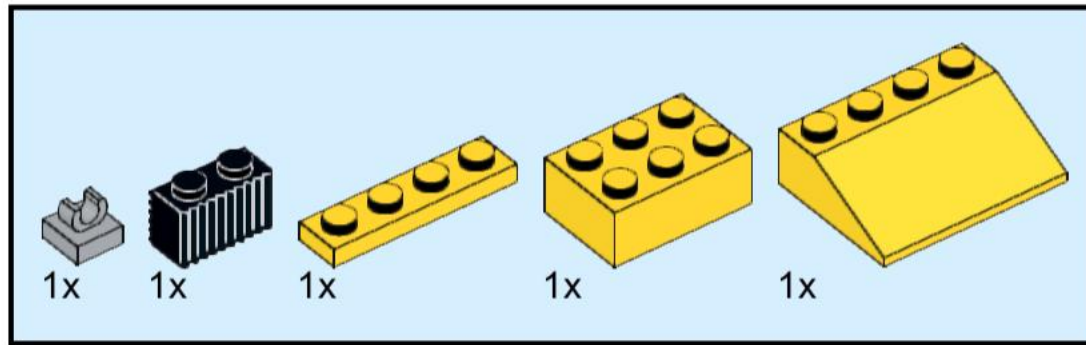

21

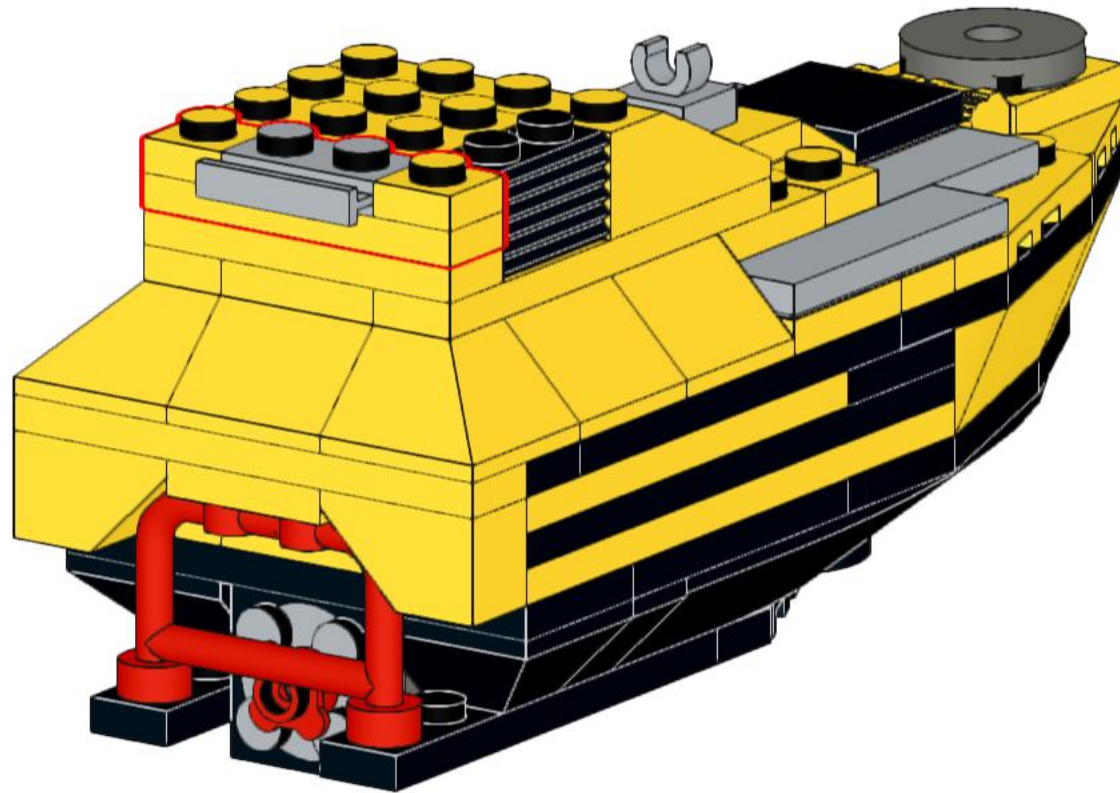
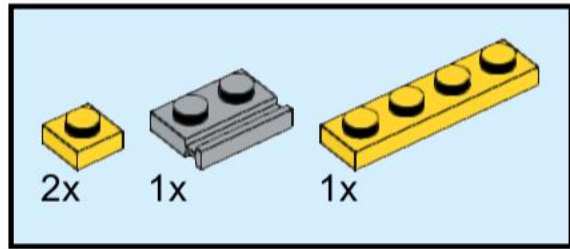

22

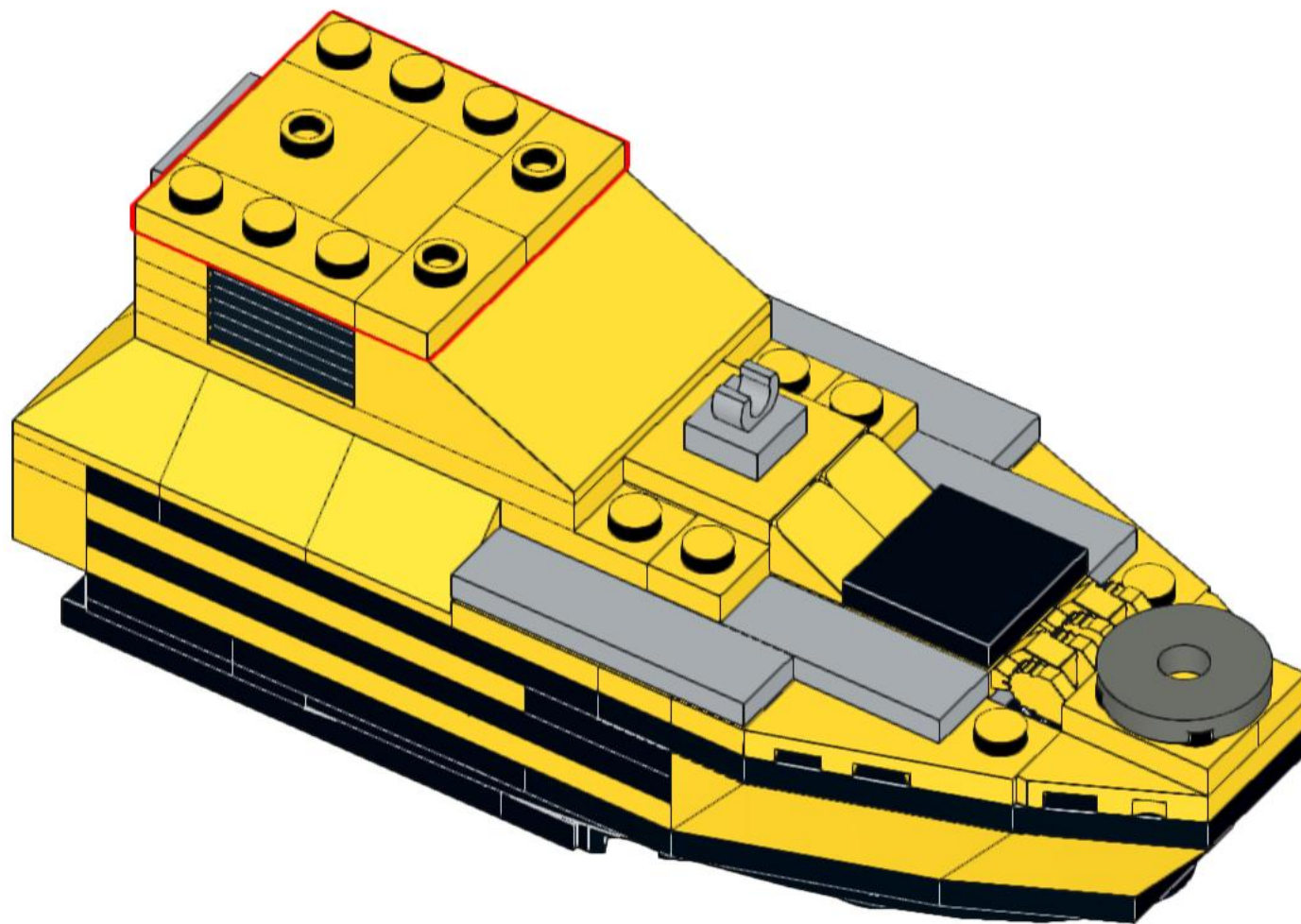
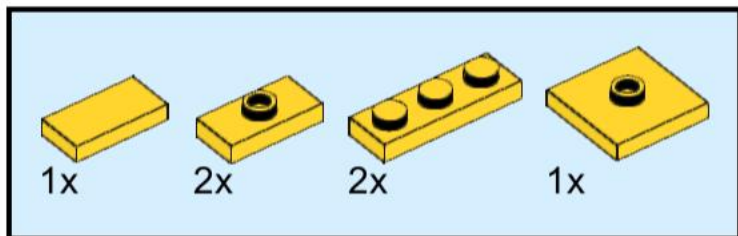

23

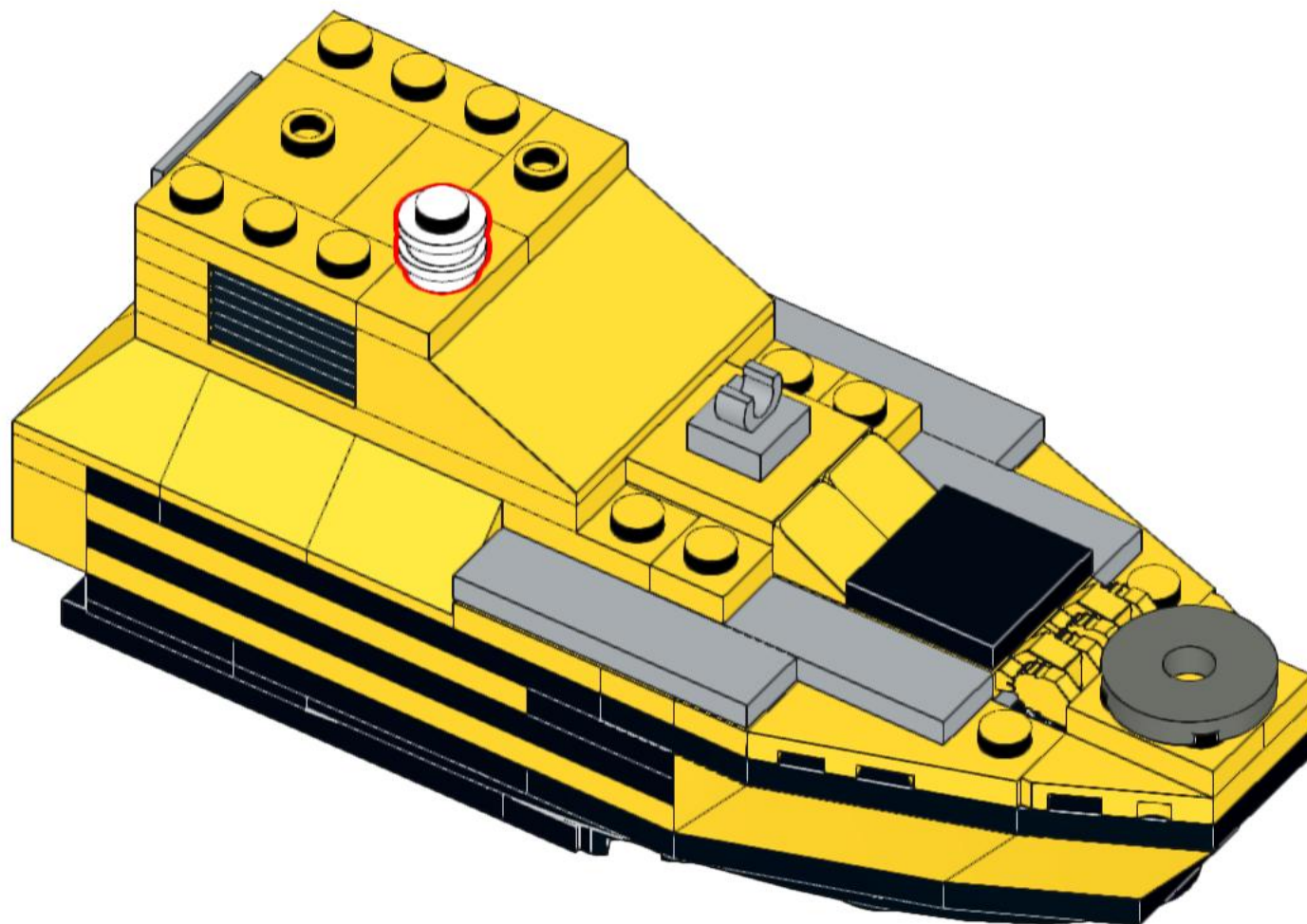
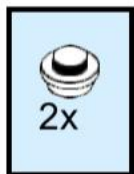

24

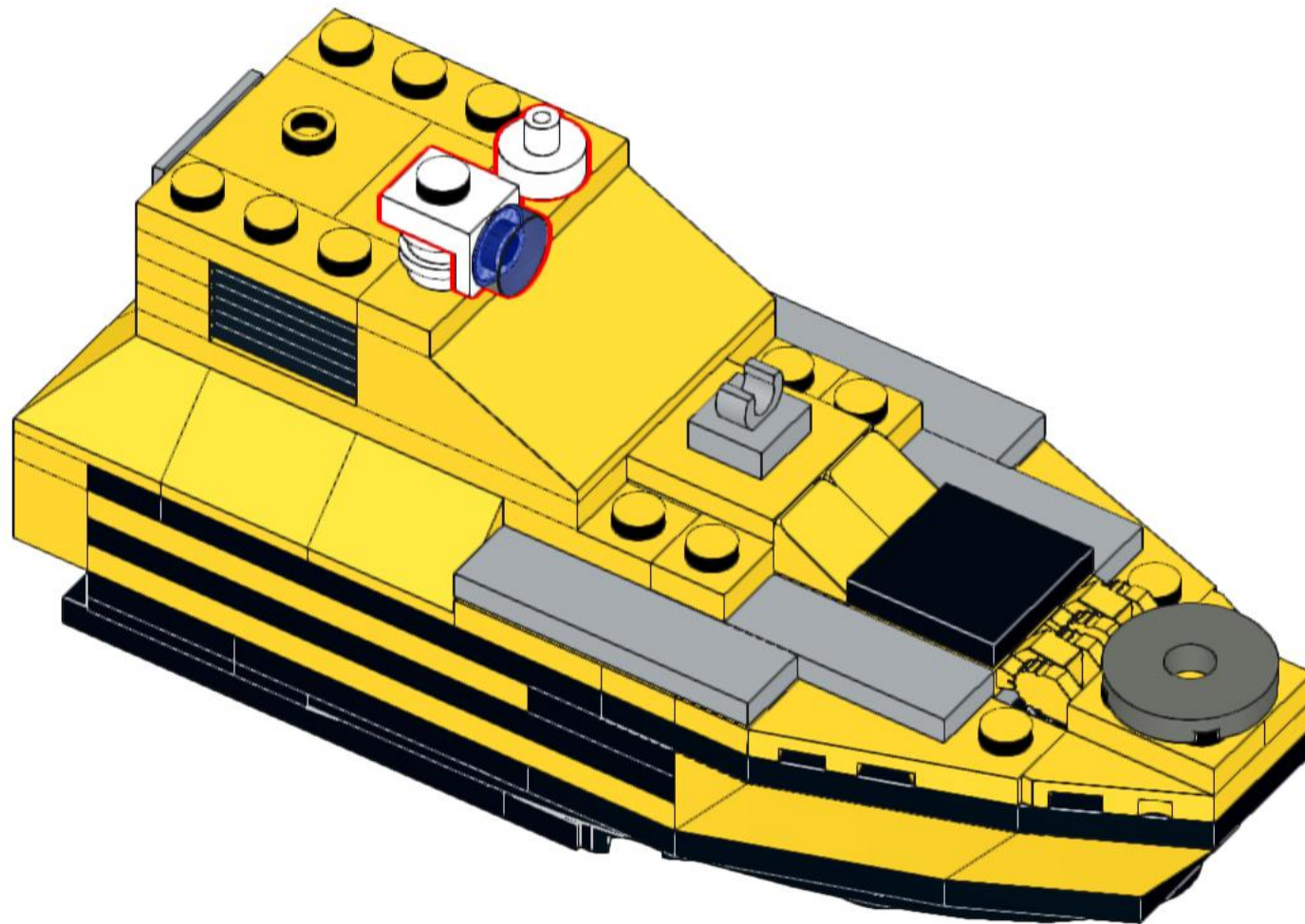
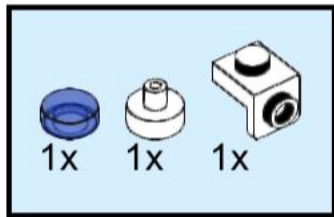

25

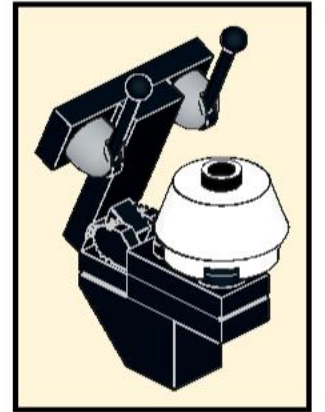
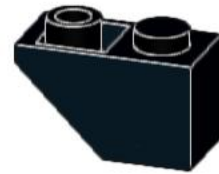
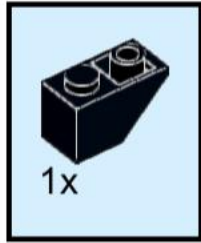

26

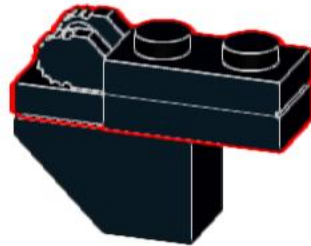
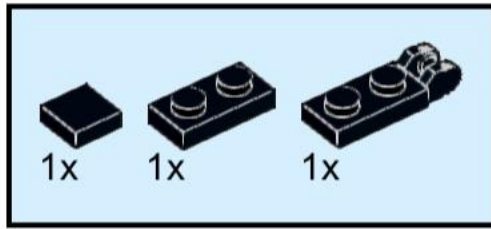

27

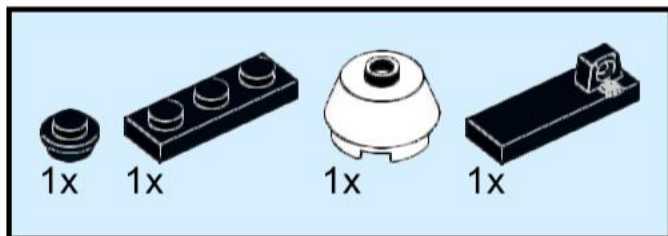

28

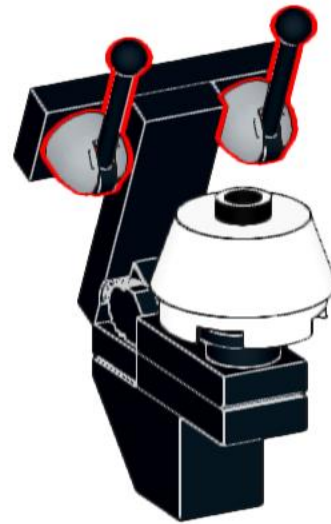
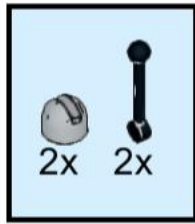

29

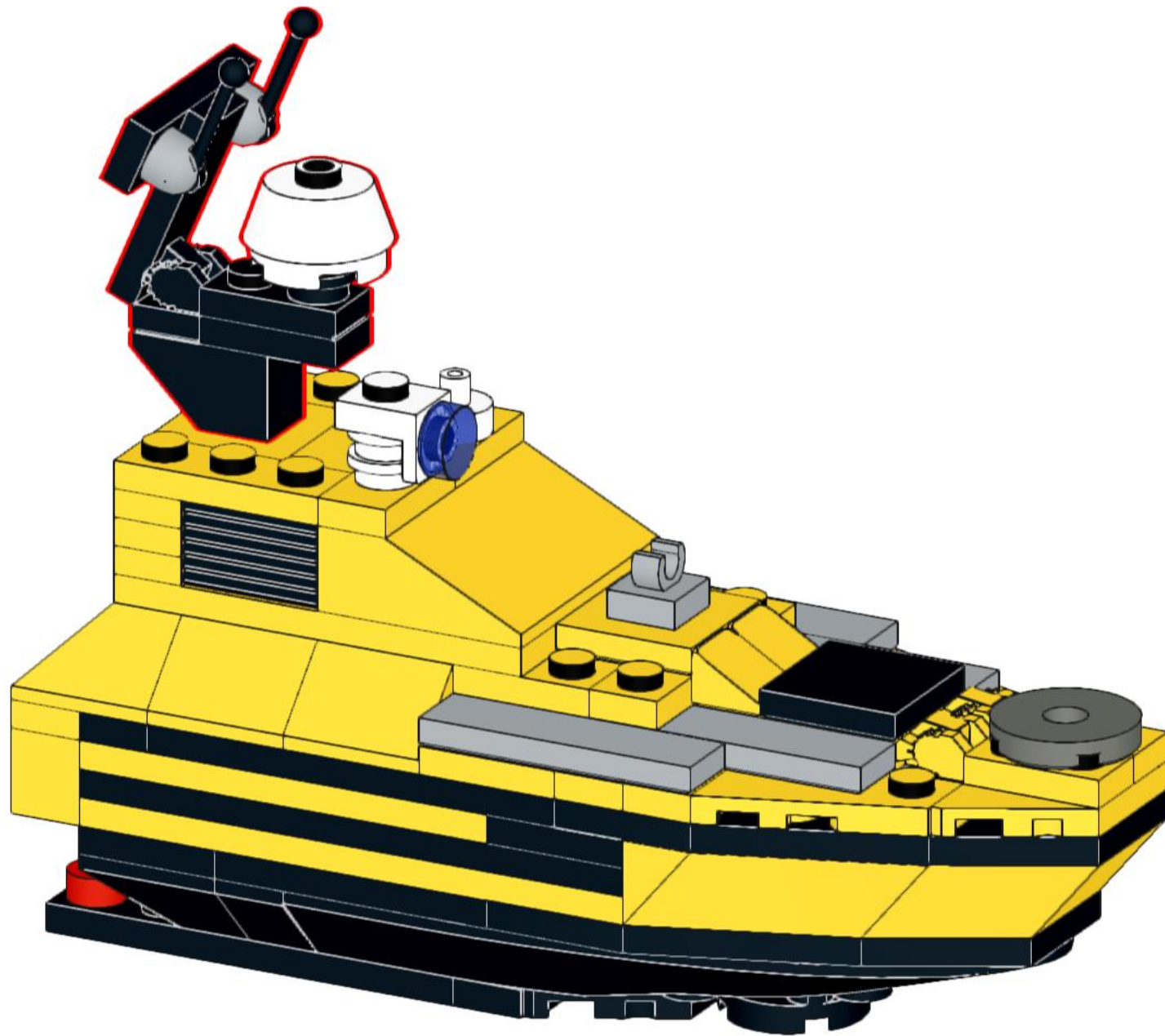



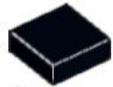

1x
3070b
Black

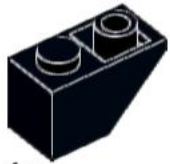

1x
3665
Black



1x
44302a
Black

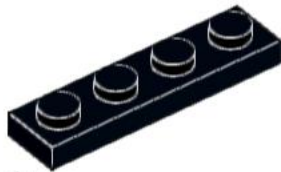

1x
3710
Black

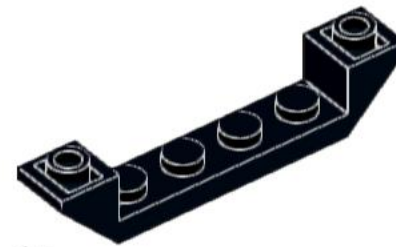

1x
52501
Black



1x
4073
Black

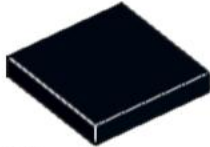

1x
3068b
Black

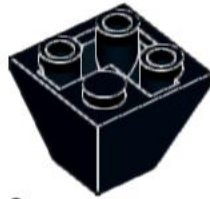

2x
3676
Black



1x
51739
Black



1x
3795
Black



2x
4593
Black

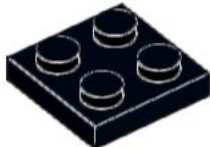

2x
3022
Black



1x
3623
Black



1x
3020
Black



1x
3032
Black



1x
3023
Black



1x
4032
Black



1x
44300
Black



3x
3666
Black



1x
2877
Black



1x
3680
Black



2x
3460
Black

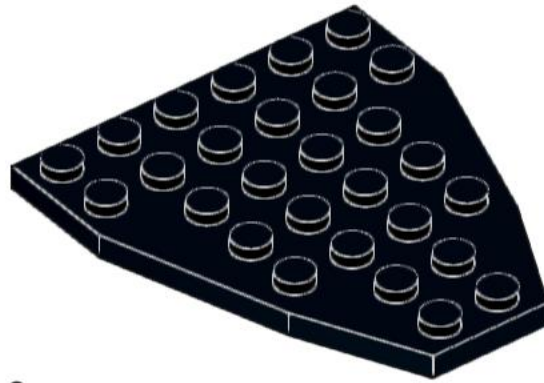

2x
2625
Black



1x
3958
Black

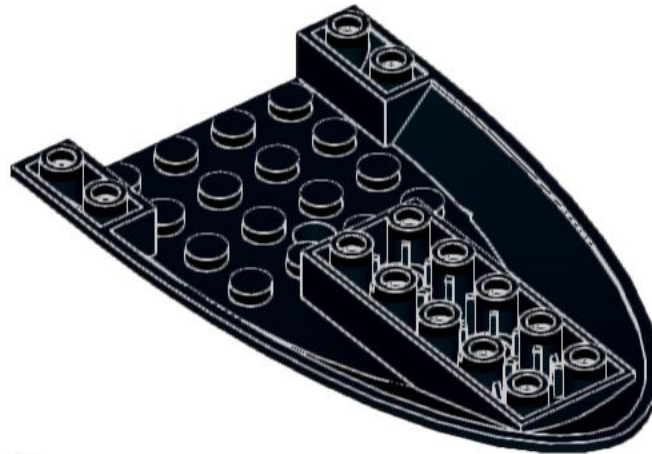

1x
87611
Black



1x
3022
Dark Bluish Gray

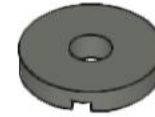

1x
15535
Dark Bluish Gray

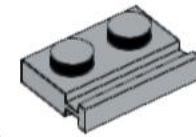

1x
32028
Light Bluish Gray



2x
4592
Light Bluish Gray

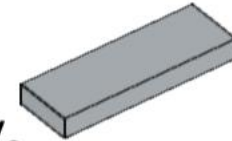

2x
63864
Light Bluish Gray

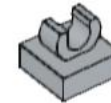

1x
15712
Light Bluish Gray

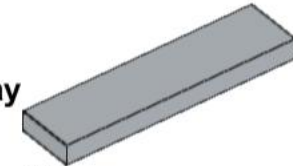

2x
2431
Light Bluish Gray



1x
3069bpb0847
Light Bluish Gray



2x
4073
White



1x
3069bpx19
Light Bluish Gray



1x
20482
White



1x
3679
Light Bluish Gray

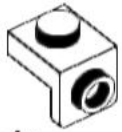

1x
36841
White

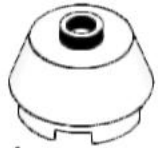

1x
98100
White



1x
33291
Red

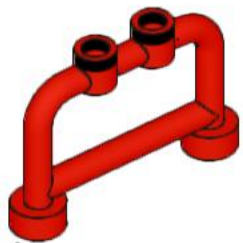

1x
4083
Red

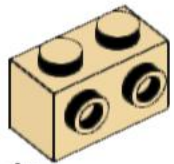

1x
11211
Tan

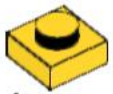

4x
3024
Yellow



2x
54200
Yellow

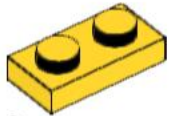

3x
3023
Yellow

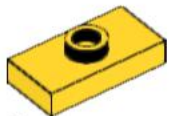

2x
3794a
Yellow

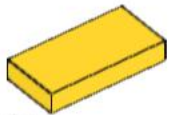

1x
3069b
Yellow

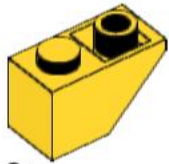

2x
3665
Yellow

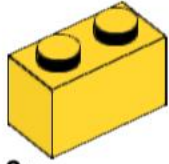

3x
3004
Yellow

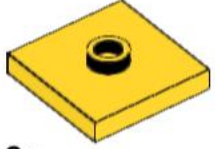

2x
87580
Yellow

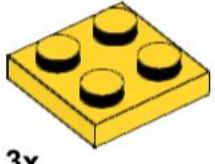

3x
3022
Yellow

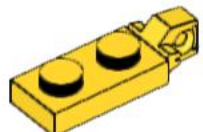

2x
44301b
Yellow

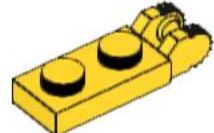

2x
44302b
Yellow

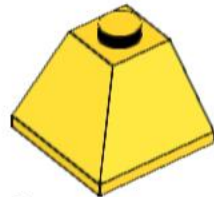

2x
3045
Yellow

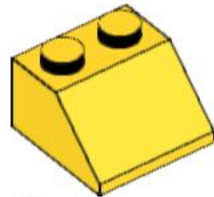

5x
3039
Yellow

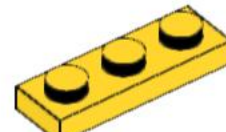

2x
3623
Yellow

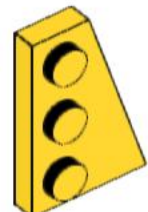

1x
43722
Yellow



1x
43723
Yellow

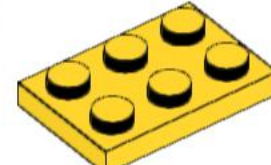

1x
3021
Yellow

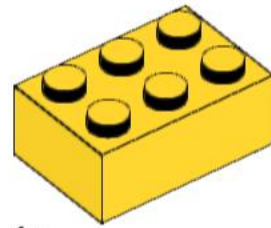

1x
3002
Yellow

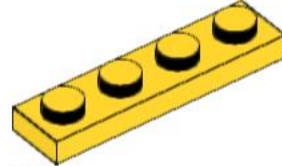

5x
3710
Yellow

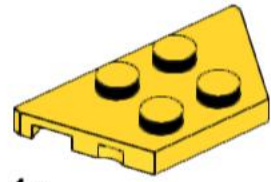

1x
51739
Yellow

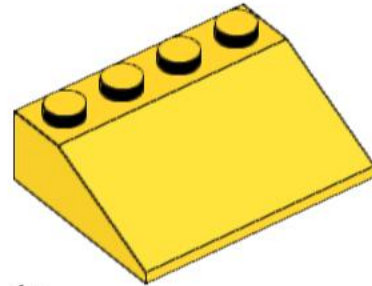

1x
3297
Yellow

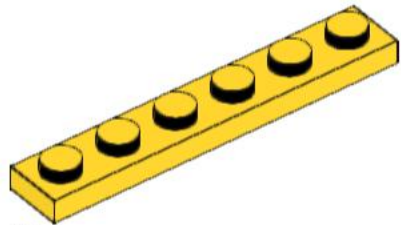

4x
3666
Yellow

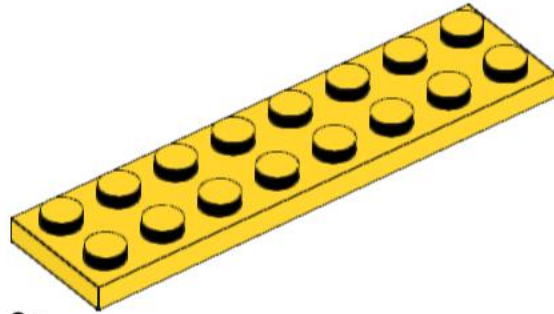

2x
3034
Yellow

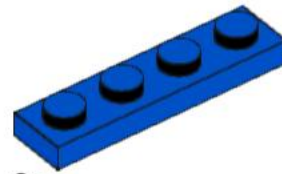

2x
3710
Blue

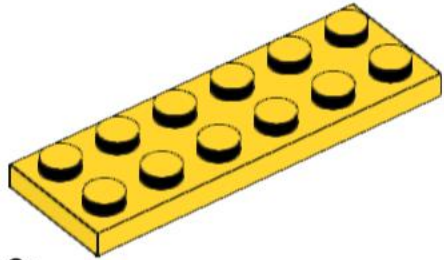

2x
3795
Yellow

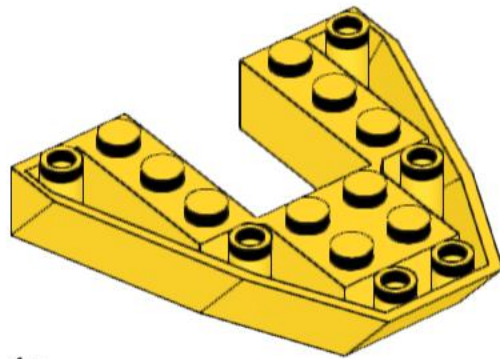

1x
2626
Yellow

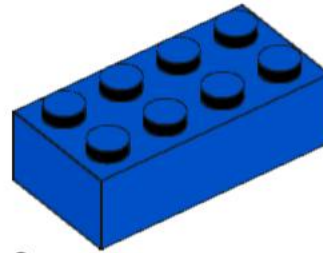

2x
3001
Blue

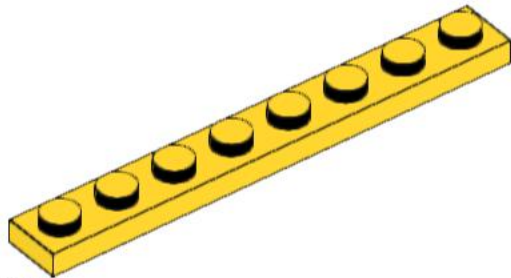

2x
3460
Yellow



1x
98138
Trans-Dark Blue

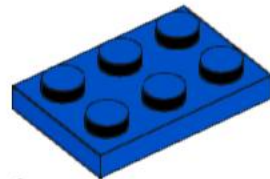

1x
3021
Blue

UNH CCOM/JHC is responsible for the contents of this booklet.

Model(s) and booklet designed by Will Fessenden, 2023.

Edited by Colleen Mitchell.



Visit our website: <https://ccom.unh.edu>

Check out the rest of our models here: <https://ccom.unh.edu/lego-model-instructions>

And visit the UNH School of Marine Science and Ocean Engineering website: <https://marine.unh.edu/>

